

Łukasz Kapłon\* and Gabriel Moskal

# Blue-emitting polystyrene scintillators for plastic scintillation dosimetry

<https://doi.org/10.1515/bams-2021-0088>

Received July 12, 2021; accepted August 24, 2021;

published online September 6, 2021

## Abstract

**Objectives:** Purpose of this research was to find the best blue-emitting fluorescent substance for plastic scintillator used for gamma radiation dosimetry. Scintillator should convert gamma radiation into blue light with high efficiency.

**Methods:** Plastic scintillators with fixed concentration of various fluorescent additives, called wavelength shifters, absorbing ultraviolet light and emitting blue light were manufactured by radical bulk polymerization of styrene. Light output were measured and compared to the light output of commercial plastic scintillator.

**Results:** Performed measurements of charge Compton spectra confirmed usefulness of majority of researched substances as wavelength shifters in plastic scintillators with emission maximum at blue range of visible light.

**Conclusions:** Plastic scintillation dosimeter may be constructed from manufactured polystyrene-based scintillators. Performance of synthesized scintillators is close to commercial polystyrene scintillators.

**Keywords:** blue laser dye; fluorescent dye; gamma radiation detector; plastic scintillator; plastic scintillation dosimetry; polystyrene scintillator; wavelength shifter; WLS.

## Introduction

Plastic scintillation dosimetry is a technique allowing to measure and verify dose delivered into patient body during

cancer treatment [1]. Plastic scintillation dosimeter is composed with a few millimeters piece of plastic scintillator glued to optical fiber. Scintillator is covered by reflecting foil or painted with white reflecting paint to increase light signal entering to optical fiber [2]. Scintillator converts absorbed radiation into visible light. Light emitted by scintillator is transported by optical fiber to light detector which converts it into electrical pulses collected by acquisition electronics. Part of dosimeter from scintillator to light detector is covered by light-tight housing to decrease influence of ambient light.

Advantages of plastic scintillation dosimeters are response independent of total dose, dose rate and angle of incidence, radiation hardness – resistance to signal loss up to 10,000 Gray of irradiation [3]. In general the amount of light in plastic scintillators is not proportional to the absorbed dose [4]. Therefore the application of plastic scintillators as dosimeters will require careful calibration.

Scintillators used in scintillation dosimetry should have density similar to density of human body about 1 g/cm<sup>3</sup>. Plastic scintillators manufactured from polystyrene (PS) or polyvinyltoluene (PVT) have density in range from 1.02 to 1.06 g/cm<sup>3</sup>. Other important property is chemical composition and low atomic number of scintillators components. Plastic scintillators have mainly carbon and hydrogen in their structure and its atomic composition is similar to water-based human tissue. Difference is that oxygen is main component in tissue and carbon is main component in plastic scintillator.

Optical properties of plastic scintillators are suitable for construction of dosimeters. The conversion efficiency of gamma radiation to visible light called light output is around 10,000 light photons per 1 MeV of absorbed gamma radiation [5]. Maxima of emission spectra of most commercial scintillator types are centered in the range from 390 to 435 nm (blue light) where maximum of quantum efficiency of light detectors is the highest.

Rise and decay time of plastic scintillator for dosimeter construction is not a major factor contrary to the time-of-flight positron emission tomography [6, 7] and total-body PET scanners [8]. In dose measurements charge of signal is collected. Many wavelength shifters (WLS) with various fluorescent decay times can be used in scintillators composition.

---

Łukasz Kapłon and Gabriel Moskal work at Total-Body Jagiellonian-PET Laboratory, Jagiellonian University, Poland.

**\*Corresponding author: Łukasz Kapłon**, PhD, Department of Experimental Particle Physics and Applications, Faculty of Physics, Astronomy and Applied Computer Science of the Jagiellonian University in Krakow, Krakow, Poland,  
E-mail: lukasz.kaplon@uj.edu.pl. <https://orcid.org/0000-0002-2203-0425>

**Gabriel Moskal**, Department of Chemical Technology, Faculty of Chemistry of the Jagiellonian University in Krakow, Krakow, Poland

Plastic scintillators usually consist of three components. Polymer base absorbing radiation and two fluorescent substances dissolved in polymer. First substance absorbs deposited energy from the polymer and emits ultraviolet light. Second substance, WLS, absorbs ultraviolet light and emits blue light. UV-emitting fluorescent dye is added because polymer has low quantum efficiency of fluorescence. Adding few percent of this dye transfers excitation energy from polymer to UV-emitting dye, which has high fluorescence quantum yield. WLS is added up to 0.1% to shift emission spectra to visible light where polymers are more transparent and blue light in scintillator can travel up to several meters [9].

Most of the used wavelength shifters are well known as laser dyes and are incorporated in commercial plastic scintillators. For example BDB was used in SCSN-38 polystyrene scintillator [10] and BBOT was added to SCSN-81 polystyrene scintillator [11], both made by Kuraray in Japan. POPOP is a WLS in UPS 923A polystyrene scintillator [12] and in BC-400 polyvinyltoluene scintillator [13].

MDAC and DPA were used in polystyrene-based plastic scintillators with pulse shape discrimination [14] capability. Lumogen F Violet 570 (LFV 570) was used in fluorescent polymer optical fibers [15] and radiation hard polysiloxane scintillator [16]. PBBO and DMPOPOP were incorporated in liquid scintillators [17].

Purpose of this work is to measure light output of polystyrene-based plastic scintillators with additions of fixed concentration of many chemical types of WLS. Manufactured scintillators have fixed concentration of one of the best UV-emitting dye and due to the addition of WLS emit light in blue part of visible spectra.

## Experiment

Polystyrene was chosen as a base of scintillators, because along with polyvinyltoluene it is one of the most common polymers for manufacturing plastic scintillators [18]. Both polymers are amorphous and transparent to visible light. Polystyrene and polyvinyltoluene are also radiation hard [19].

As a UV-emitting fluorescent dye BPBD (2-(4-tert-butylphenyl)-5-(4-biphenyl)-1,3,4-oxadiazole) was chosen with 2 wt% concentration in polystyrene. BPBD has highest light output in comparison with other UV-emitting dyes tested [5]. In all samples concentration of BPBD was 2 wt% and concentration of blue-emitting WLS was 0.05 wt%. Properties of used WLS in this work are shown in Table 1. Molecular structures of these dyes are presented in Figure 1.

Fluorescent dyes were purchased from Merck (Germany) except that  $\alpha$ -NPO which was purchased from Angene Chemical (India), BDB and DPA are from Alfa Aesar (Germany), DPH is from Acros Organics (Belgium), Lumogen F Violet 570 (LFV 570) under trade name Fluorescent Violet 94730 and Lumogen F Blue 650 (LFB 650) under name Fluorescent Blue 94736 are from Kremer Pigmente (Germany). Purity of used dyes was 99% and they were used as received. Chemical name, structure, and purity of Fluorescent Blue 94736 are not known except

**Table 1:** Properties of fluorescent dyes used in this work.

Fluorescent dye	CAS no.	Absorption maximum, nm	Emission maximum, nm	Quantum efficiency, %	Decay time, ns	Melting point, °C
Ultraviolet-emitting fluorescent dye						
BPBD	15082-28-7	304	365	85	1.2	136–138
Blue-emitting fluorescent dyes						
$\alpha$ -NPO	846-63-9	332	391	94	2.1	104–106
Bis-MSB	13280-61-0	347	420	94	1.3	178–180
BBOT	7128-64-5	372	435	74	1.1	200–202
BDB	72814-85-8	360	425			196–200
DMPOPOP	3073-87-8	370	430	93	1.5	232–234
DPA	1499-10-1	366	430	95	9.3	246–248
DPH	1720-32-7	354	425	78		200–204
LFB 650		377	411	80		175–178
LFV 570	56148-88-0	378	413	85		186–188
MDAC	91-44-1	360	416	93–99	2.8–3.4	72–75
PBBO	17064-47-0	331	396		1.2	198–199
POPOP	1806-34-4	358	415	93	1.5	243–245
Pyrene	129-00-0	335	385	32		148–150
TPB	1450-63-1	345	465	60	1.8	206–209

Data compiled from [20–24]. Optical properties are for toluene or cyclohexane diluted solutions. Melting points are taken from Reaxys database.

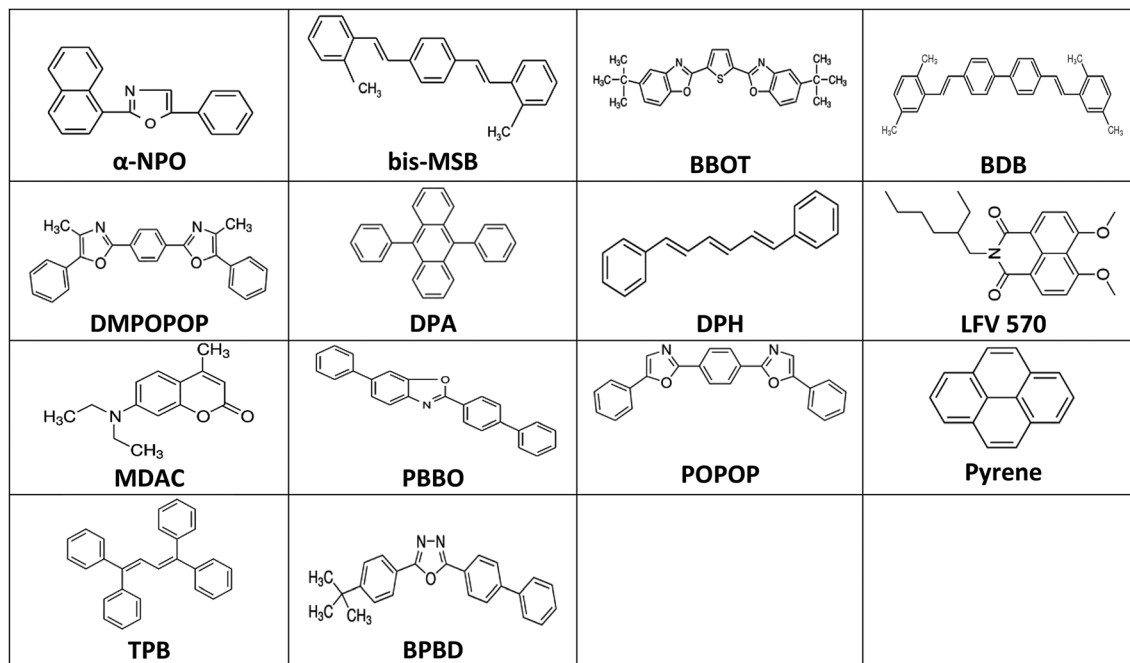

**Figure 1:** Molecular structures of fluorescent dyes used in this work. BPBD emits UV light, the rest of compounds are wavelength shifters with blue emission.

that the dye is a naphthalimide derivative. Styrene with purity 99.8% was purchased from Brenntag (Poland). Dichlorodimethylsilane 99.5%, chloroform 99%, and inhibitor removers were purchased from Merck (Germany).

Scintillators were polymerized in an electric furnace at maximum temperature 140 °C in sealed glass ampoules applying temperature cycle that lasts few days as described in Ref. [25]. In order to facilitate an easy removal of plastic samples from glass, ampoules were silanized overnight with use of 20% solution of dichlorodimethylsilane in chloroform. Styrene monomer was purified from polymerization inhibitor and other impurities by passing through glass column with basic activated alumina.

Scintillator samples were machined to cylinders 25 mm diameter and 10 mm height. Side surface was as cast from glass mold, top and bottom part were polished with use of waterproof sandpapers with gradation from P600 to P4000 and polishing paste. Side and top surface in all samples were wrapped with 6 layers of white Teflon tape with thickness 0.2 mm. Photographs of manufactured samples are presented in Figure 2.

To measure optical properties of manufactured scintillators bottom surface of samples was covered with optical grade silicone grease BC-630 from Saint-Gobain Crystals (USA) and attached to R9800 photomultiplier tube (PMT) from Hamamatsu (Japan). PMT with wrapped samples was enclosed in light tight aluminum housing with electric PMT's base and mu-metal shielding, see Figure 3. PMT was supplied with 1250 V from CAEN N470 power supply. Signal was read out by Desktop Digitizer CAEN DT5743. Scintillators were excited by Cs-137 low intensity gamma source positioned 100 mm from scintillator samples. Top part of PMT with sample was sealed with light-tight cover.

## Results

Light output was compared with EJ-200 reference PVT-based plastic scintillator from Eljen Technology (USA) with the same shape, dimensions and Teflon wrapping. Samples light output were determined by finding middle of Compton edge in charge spectra and comparing it to middle of Compton edge for EJ-200 sample which has light output 10,000 photons/MeV [26]. Middle of Compton edge was found by fitting part of Gaussian function to charge histograms drawn in Origin software. Example of charge spectra is presented in Figure 4.

The light output is proportional to the charge measured. Charge of signal is calculated as the integral of a signal in picocoulombs (pC). Positions of middle of Compton edge in charge spectra were used in ordering measurements results which are presented in Table 2 and Figure 5. Each sample was measured three times and light output values in Table 2 are averages. The accuracy of a relative light output value between three measurements of the same sample is 2%.

Second type of analysis was performed to calculate rise and fall times of 50,000 signals collected for each sample. Rise time is a time in which signal is increasing from 10% to 90% of its maximum amplitude. Fall time is a time in which

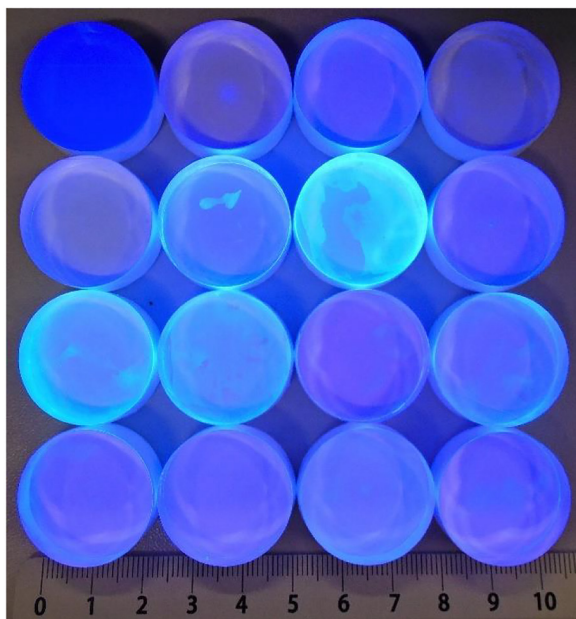
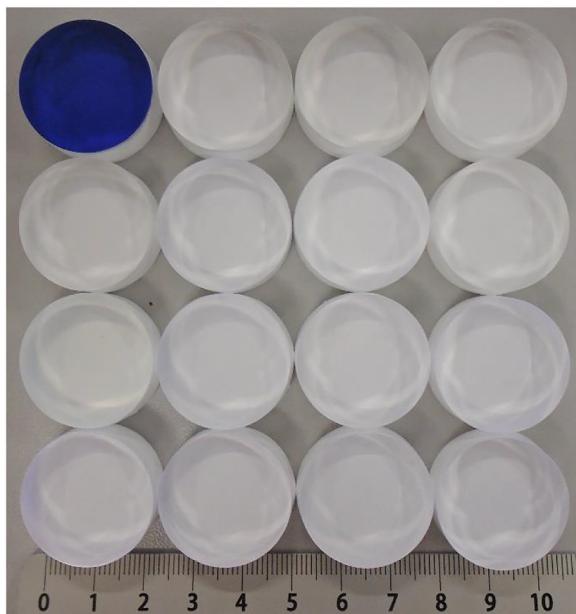

**Figure 2:** Photograph of manufactured plastic scintillator samples under ambient light (top) and UV light (bottom). The graduation on the ruler is in centimeters. Samples have 25 mm diameter and 10 mm height and are wrapped in white teflon tape. Samples are ordered from top left as in Table 2 with results of light output measurements.

signal is decreasing from 90% to 10% of its amplitude. These two values were averaged from 50,000 signals saved for every measured scintillator. Both measurements were analyzed with custom made software calculating charge, rise and fall times of signals.

Polystyrene-based plastic scintillators with the best light output calculated with charge spectra are those

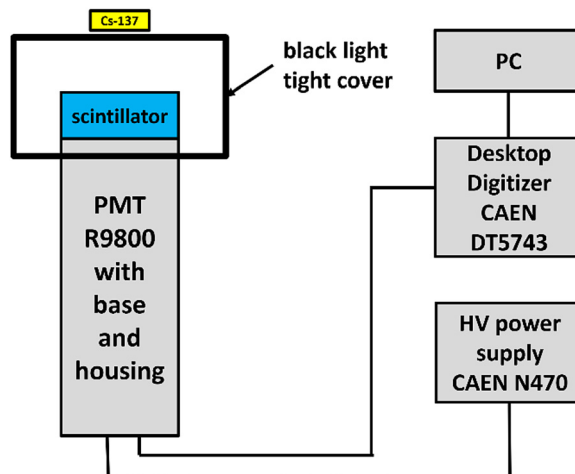

**Figure 3:** Experimental setup used for light output and timing measurements.

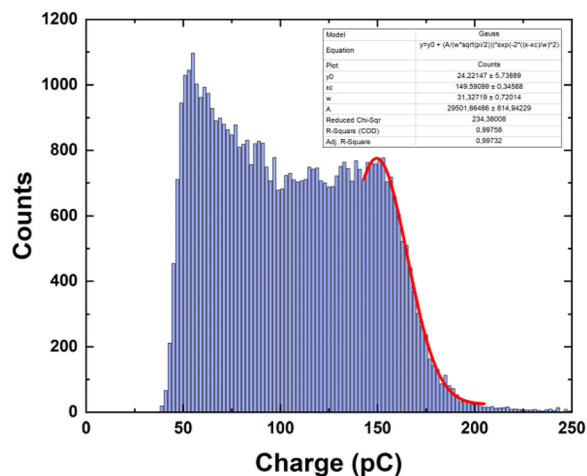

**Figure 4:** Example of charge Compton spectra of plastic scintillator with fitted Gauss function (red line). Excitation source was Cs-137.

containing PBBO, BBOT, DMPOPOP, MDAC, POPOP, DPA, bis-MSB and LFB 570 as wavelength shifters.

Large difference in WLS fall times was observed. LFB 650, MDAC, DPA and LFB 570 have fall time 14.93 ns, 12.82 ns, 22.33 ns and 17.92 ns, respectively. Deposited charge is spread out in longer time and amplitude spectra for LFB 650, MDAC, DPA and LFB 570 have smaller value. Signals from these samples have comparable charge spectra but amplitudes are smaller than in samples containing WLS with faster fall time as with PBBO, POPOP and bis-MSB.

Sample containing 2% BPBD only was also measured. Scintillator without WLS has about 40% lower light output than the best samples with WLS, calculated with charge

**Table 2:** Light output and timing properties of synthesized polystyrene scintillators with 2% BPBD and 0.05% WLS.

WLS	Light output, photons/MeV	Rise time, ns	Fall time, ns
LFB 650	2,547	2.24	14.93
Pyrene	3,734	1.34	4.90
$\alpha$ -NPO	4,452	1.46	7.91
None	4,602	1.37	5.35
DPH	4,884	1.38	6.68
BDB	5,332	1.52	6.30
TPB	6,216	1.67	8.76
PBBO	6,413	1.45	6.47
BBOT	6,615	1.65	7.61
DMPOPOP	7,052	1.63	7.53
MDAC	7,155	1.88	12.82
POPOP	7,222	1.56	7.06
DPA	7,291	2.62	22.33
Bis-MSB	7,424	1.60	7.29
LFV 570	7,491	2.32	17.92
EJ-200	10,000	1.74	7.81

Samples are sorted in ascending order of light output calculated with charge Compton spectra. EJ-200 is a reference sample.

spectra. Rise and fall times of samples without WLS are the fastest in the researched group.

In three scintillators samples with LFB 650, pyrene, and  $\alpha$ -NPO as WLS measured light output was lower than for scintillator without WLS. Sample with LFB 650 was dark blue and light was strongly attenuated. Possible explanation for low performance for pyrene and  $\alpha$ -NPO is that these two dyes have absorption spectra not matched with emission spectra of BPBD. Energy transfer between UV-emitting BPBD and blue-emitting pyrene and  $\alpha$ -NPO is not efficient. Additionally pyrene and  $\alpha$ -NPO have emission spectra maximum below 400 nm and light is more attenuated than for compounds with emission spectra centered above 400 nm.

Light output around 7500 photons/MeV of the best samples calculated with charge spectra is in the range of commercial polystyrene scintillators. For example polystyrene scintillators UPS 923A from Amcrys and SP32 from Nuviatch Instruments emit 8750 photons/MeV.

Timing properties of few samples are better than for reference EJ-200 sample. BDB, PBBO, BBOT, DMPOPOP, POPOP and bis-MSB have smaller rise and fall times than EJ-200. PBBO, POPOP and bis-MSB combine fast timing properties with high light output.

Emission spectra of polystyrene scintillators with two best wavelength shifters are depicted in Figure 6. These spectra are taken from Ref. [27]. Maxima of emission spectra are positioned around 420 nm where most PMTs have maximum quantum efficiency for light to

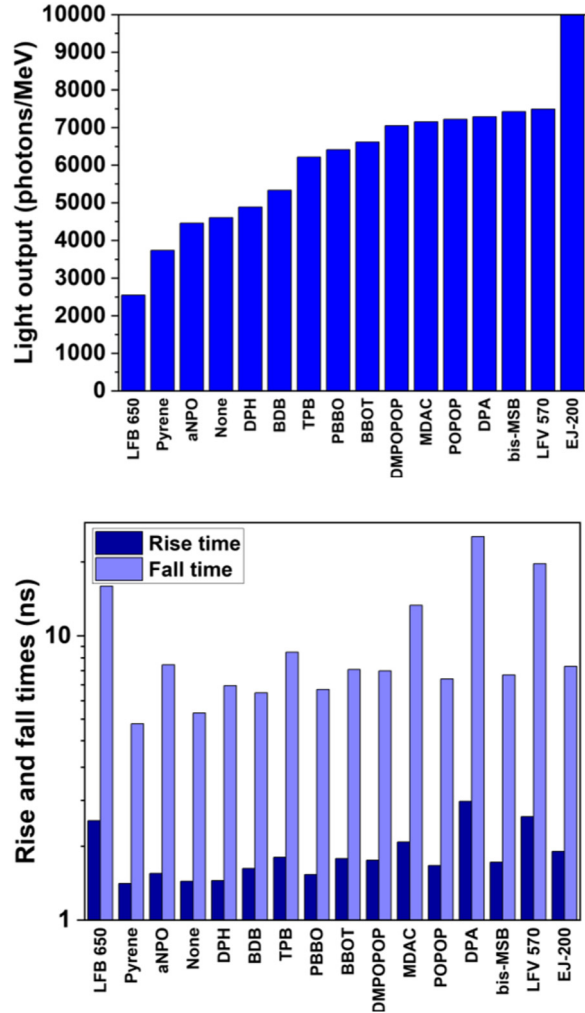
**Figure 5:** Charts with measurement results: light output (top) and timing of signals (bottom).

electric signal conversion. POPOP and bis-MSB wavelength shifters have combination of highest light output and shortest fall time which is beneficial for many applications of scintillators.

## Conclusions

14 blue-emitted wavelength shifters were tested in view of their application as components of plastic scintillators. It was established that 10 fluorescent dyes (Table 2) have moderate to high light output and can be used for construction of plastic scintillation dosimeters. Since gamma intensity in time (fluence) in therapeutic beam is very high even plastic scintillators with moderate light output and longer decay time can be used as part of dosimeter.

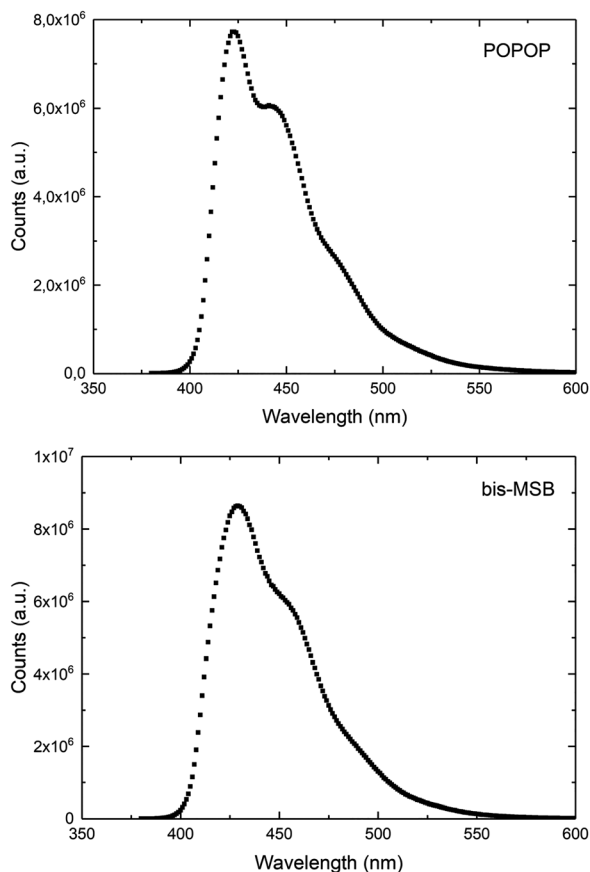

**Figure 6:** Emission spectra of polystyrene scintillators with POPOP and bis-MSB as WLS. Maximum for POPOP is 422 nm and for bis-MSB is 429 nm.

**Acknowledgments:** We acknowledge the technical support of W. Migdał and scientific support of M. Silarski and F. Sobczuk.

**Research funding:** This work was supported by grant for the early stage of research financing from Centre for Technology Transfer CITTRU from the Jagiellonian University in 2021; the National Science Centre of Poland through grant OPUS No. 2019/35/B/ST2/03562 and the Jagiellonian University under project No. CRP/0641.221.2020.

**Author contribution:** All authors have accepted responsibility for the entire content of this manuscript and approved its submission.

**Competing interests:** Authors state no conflict of interest.

**Informed consent:** Not applicable.

**Ethical approval:** Not applicable.

## References

1. Beddar S, Beaulieu L. Scintillation dosimetry. Boca Raton: CRC Press; 2016.

2. Beddar S, Beaulieu L. Review of plastic and liquid scintillation dosimetry for photon, electron, and proton therapy. *Phys Med Biol* 2016;61:R305–43.
3. Beddar S, Mackie R, Attix H. Water-equivalent plastic scintillation detectors for highenergy beam dosimetry: II. Properties and measurements. *Phys Med Biol* 1992;37:1901–13.
4. Swiderski L, Marcinkowski R, Moszynski M, Czarnacki W, Szawłowski M, Szczesniak T, et al. Electron response of some low-Z scintillators in wide energy range. *J Inst Met* 2012;7: 06011.
5. Kaplon L. Synthesis and characterization of plastic scintillators for the total-body J-PET scanner. *Acta Phys Pol B* 2020;51: 225–30.
6. Moskal P, Stepień E. Prospects and clinical perspectives of total-body PET imaging using plastic scintillators. *Pet Clin* 2020;15: 439–52.
7. Moskal P, Jasinska B, Stepień E, Bass S. Positronium in medicine and biology. *Nat Rev Phys* 2019;1:527–9.
8. Vandenberghe S, Moskal P, Karp J. State of the art in total body PET. *EJNMMI Phys* 2020;7:35.
9. Kaplon L. Technical attenuation length measurement of plastic scintillator strips for the total-body J-PET scanner. *IEEE Trans Nucl Sci* 2020;67:2286–9.
10. Kamon T, Kondo K, Yamashita A, Shimizu T, Nodulman L. A new scintillator and wavelength shifter. *Nucl Instrum Methods* 1983; 213:261–9.
11. Biagtan E, Goldberg E, Harmon J, Stephens R. Effect of gamma radiation dose rate on the light output of commercial polymer scintillators. *Nucl Instrum Methods Phys Res B* 1994;93: 296–301.
12. Artikov A, Budagov J, Chirikov-Zorin I, Chokheli D, Lyablin M, Belletini G, et al. Properties of the Ukraine polystyrene-based plastic scintillator UPS 923A. *Nucl Instrum Methods Phys Res* 2005;555:125–31.
13. Horrocks D, Peng C. Organic scintillators and liquid scintillation counting. New York and London: Academic Press; 1971.
14. Zaitseva N, Glenn A, Mabe A, Carman M, Hurlbut C, Inman J, et al. Recent developments in plastic scintillators with pulse shape discrimination. *Nucl Instrum Methods Phys Res* 2018;889: 97–104.
15. Parola I, Arrosipide E, Recart F, Illarramendi MA, Durana G, Guarrotxena N, et al. Fabrication and characterization of polymer optical fibers doped with perylene-derivatives for fluorescent lighting applications. *Fibers* 2017;5:28.
16. Quaranta A, Carturan S, Cinausero M, Marchi T, Gramegna F, Degerlier M, et al. Characterization of polysiloxane organic scintillators produced with different phenyl containing blends. *Mater Chem Phys* 2013;137:951–8.
17. Kowalski E, Anliker R, Schmid K. Performance parameters of some new efficient and highly soluble solutes for liquid scintillators. *Mol Cryst* 1968;4:403–13.
18. Wiczorek A, Dulski K, Niedzwiecki S, Alfs D, Bialas P, Curceanu C, et al. Novel scintillating material 2-(4-styrylphenyl)benzoxazole for the fully digital and MRI compatible J-PET tomograph based on plastic scintillators. *PLoS One* 2017;12:e0186728.
19. Kharzheev Y. Radiation hardness of scintillation detectors based on organic plastic scintillators and optical fibers. *Phys Part Nucl* 2019;50:42–76.

20. Birks J. Solutes and solvents for liquid scintillation counting. Colnbrook: Koch-Light Laboratories; 1969.
21. Berlman I. Handbook of fluorescence spectra of aromatic molecules, 2nd ed. New York and London: Academic Press; 1971.
22. Exciton Luxottica. Laser and fluorescent dyes; 2021. Available from: <https://exciton.luxottica.com/laser-dyes.html>.
23. PhotoChemCAD chemicals; 2018. Available from: <https://omlc.org/spectra/PhotochemCAD/index.html>.
24. Colorants for plastics colorations, technical information. Ludwigshafen: BASF; 2005.
25. Kaplón L, Kochanowski A, Molenda M, Moskal P, Wieczorek A, Bednarski T, et al. Plastic scintillators for positron emission tomography obtained by the bulk polymerization method. BAMS 2014;10:27–31.
26. Eljen Technology. General purpose plastic scintillator EJ-200, EJ-204, EJ-208, EJ-212; 2021. Available from: <https://eljentechnology.com/25-resources/75-data-sheets>.
27. Kaplón L. Synthesis and characterization of polystyrene scintillators and their application in positron emission tomography [Ph.D. Thesis]. Krakow: Jagiellonian University; 2017.